

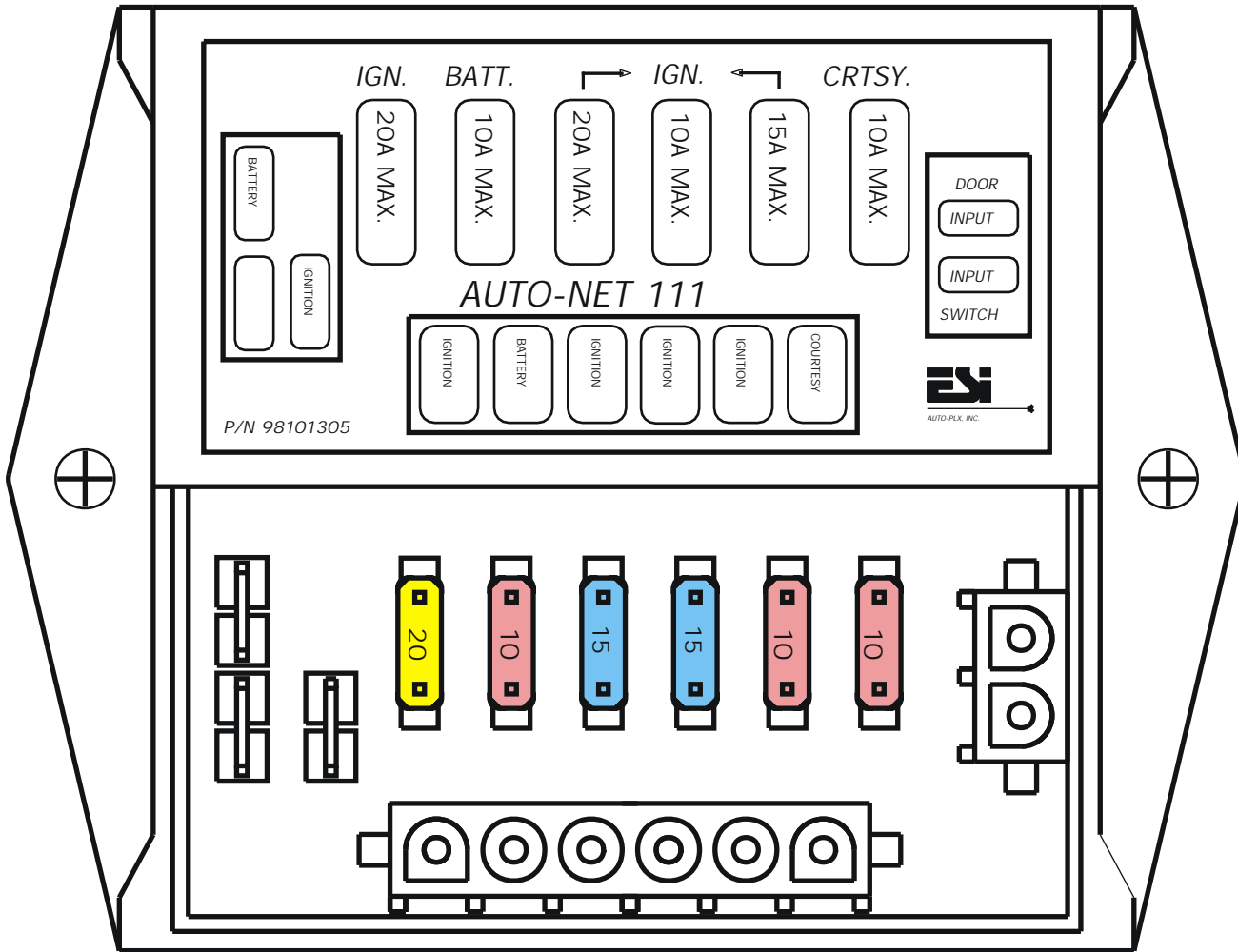

PUBLICATION DESIGN TEAM

1999
SE
SWITCH PLATE
AND
ELECTRICAL COMPONENT
TROUBLE SHOOTING
GUIDE

AUTO-NET 111 FUSE BLOCK



PIN CONNECTIONS

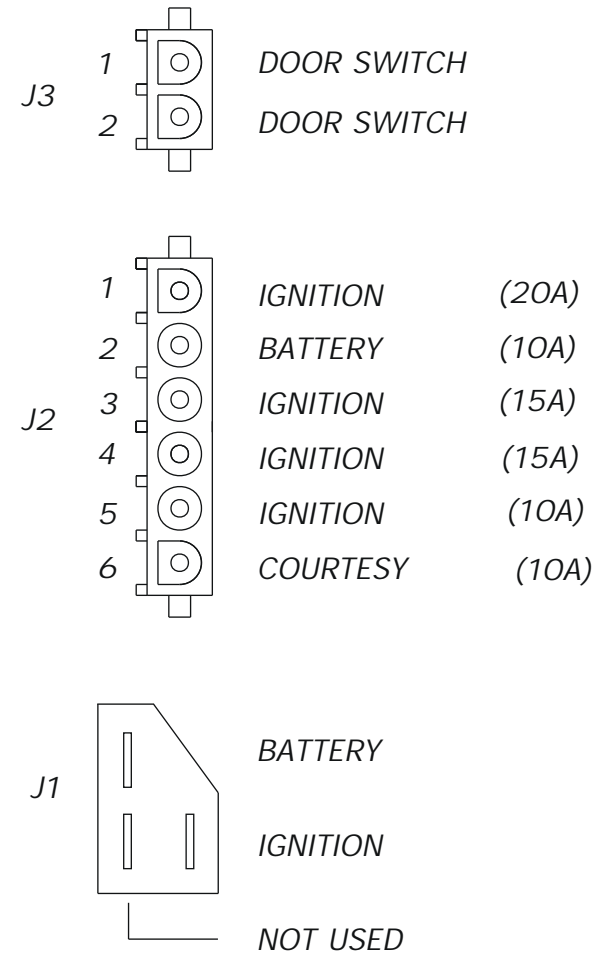

21270046

FUSE TYPE

AUTOMOTIVE MINI FUSE

AUTO-NET 111

SE/PTV Fuse Block plus Courtesy Light Function Troubleshooting Flowchart

Page 1 of 1

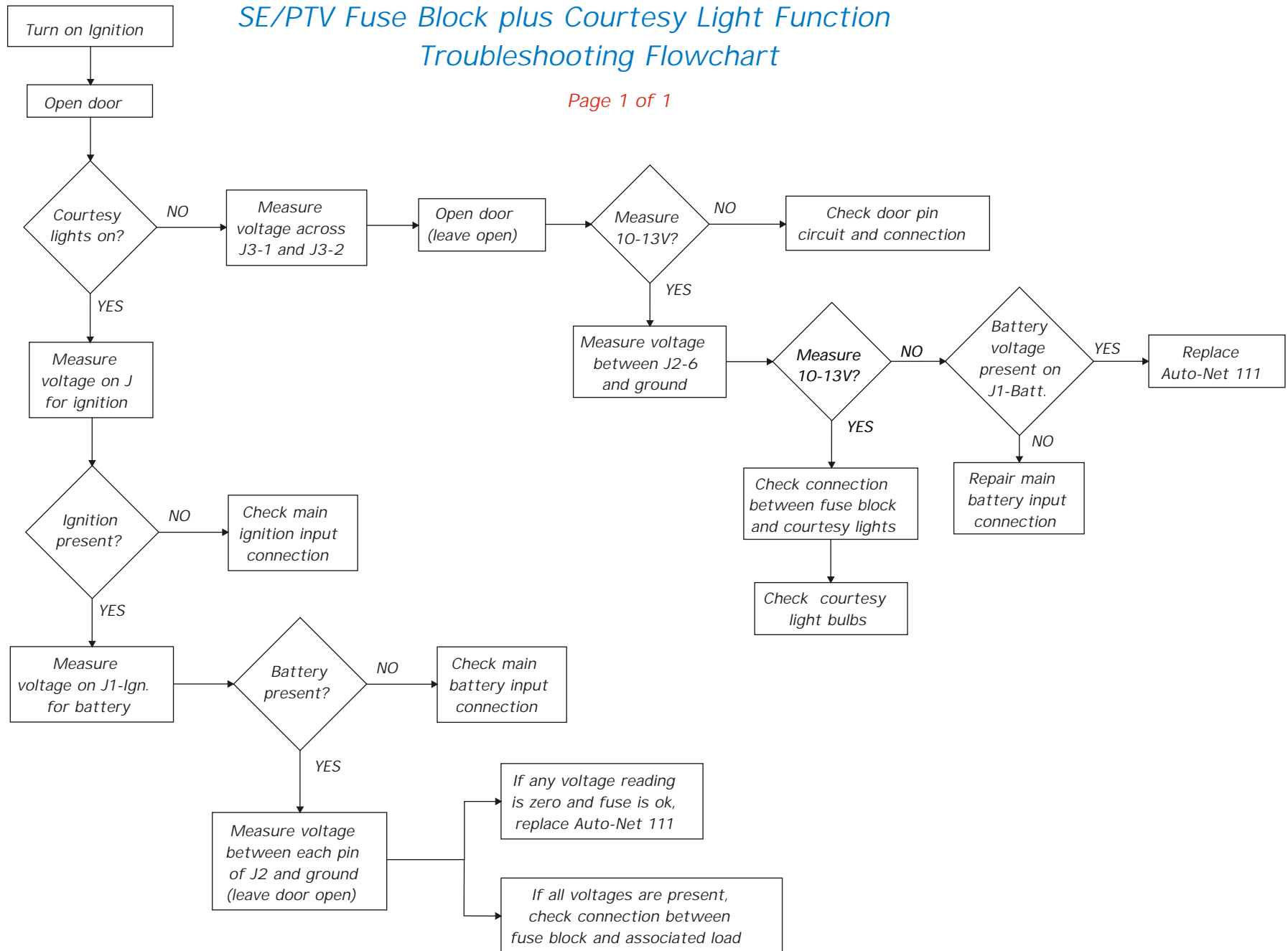

AUTO-NET 210 SOFA CONTROLLER

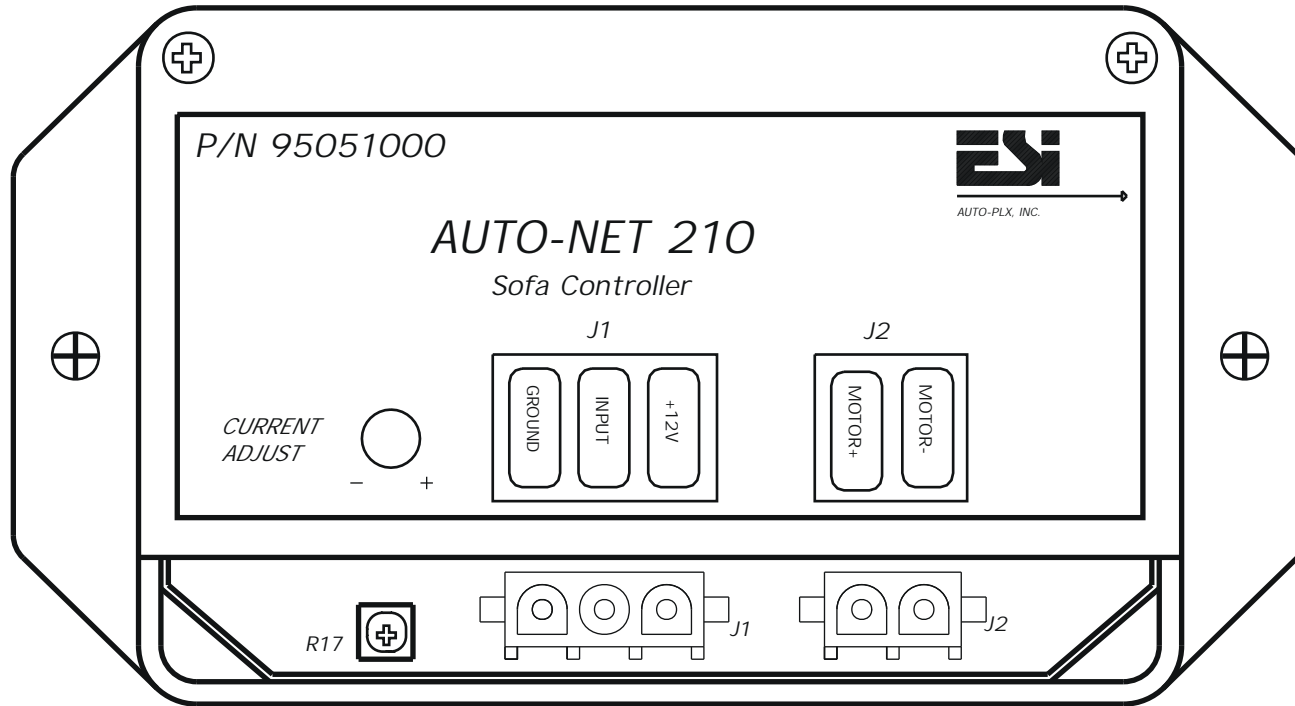

PIN CONNECTIONS

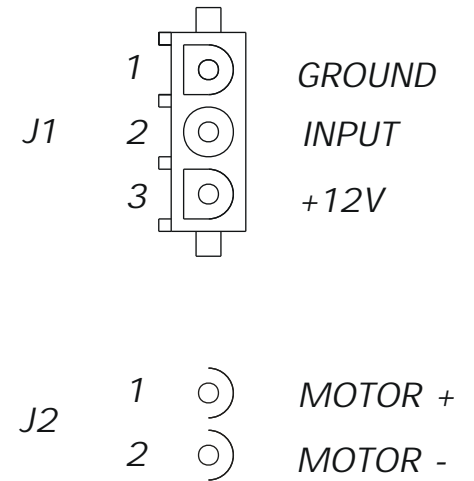

21270057

SOFA Troubleshooting Flowchart

Page 1 of 1

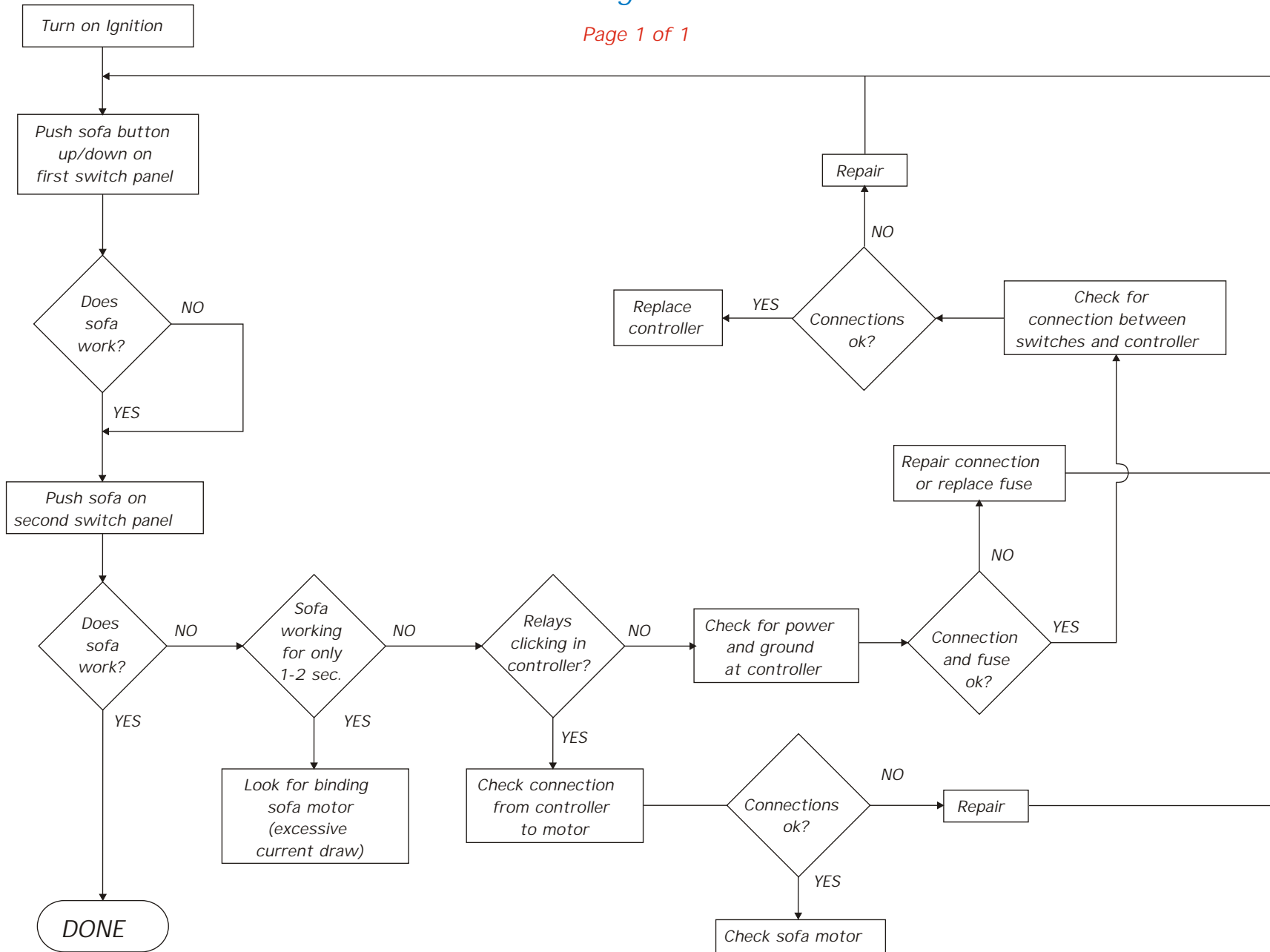

AUTO-NET 440 LOAD MANAGER

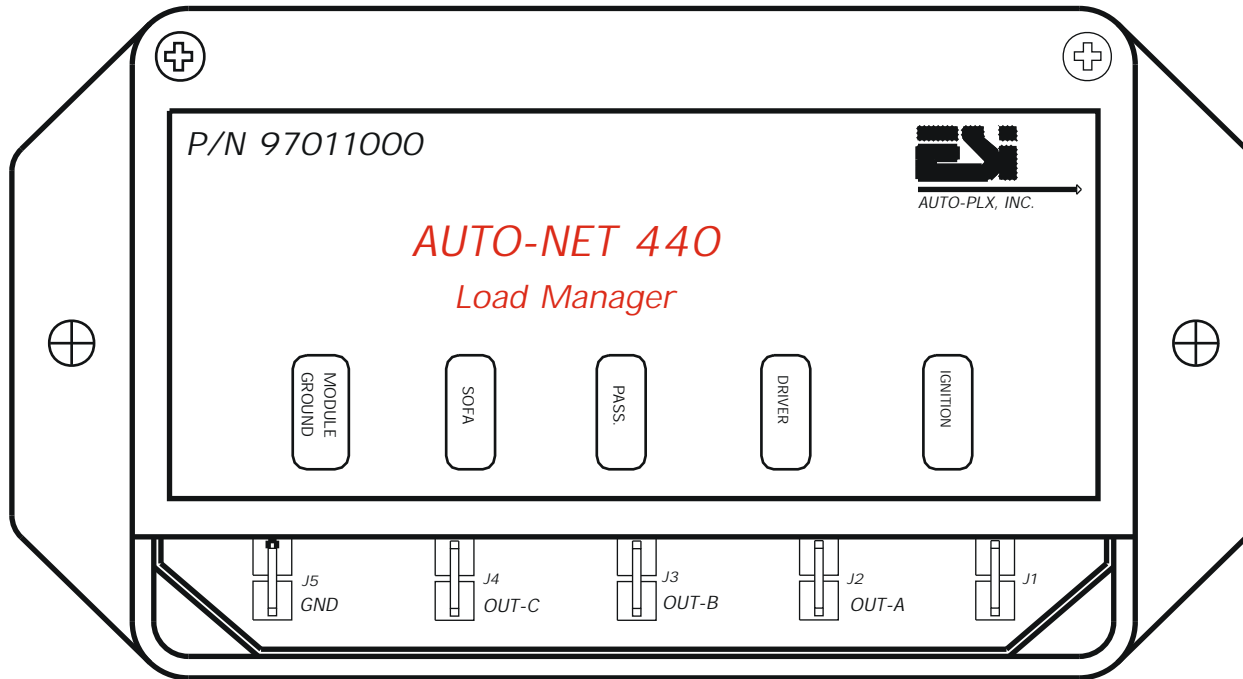

J1- IGNITION

J2- DRIVER

J3- PASSENGER

J4- SOFA

J5- MODULE GROUND

13260157

AUTO-NET 440 Power Seats / Sofa Power Source Troubleshooting Flowchart

Page 1 of 1

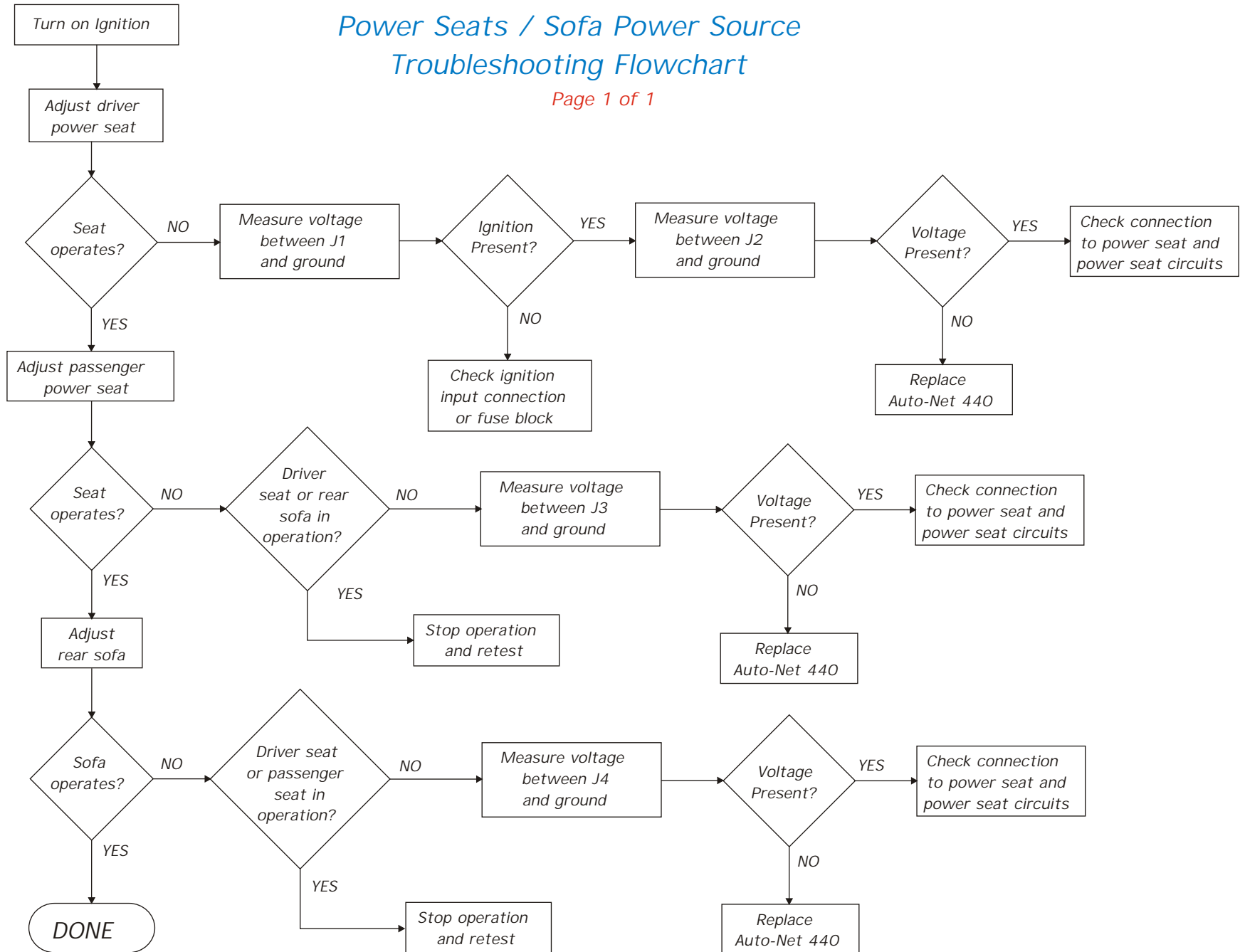

HEADPHONE STATIONS

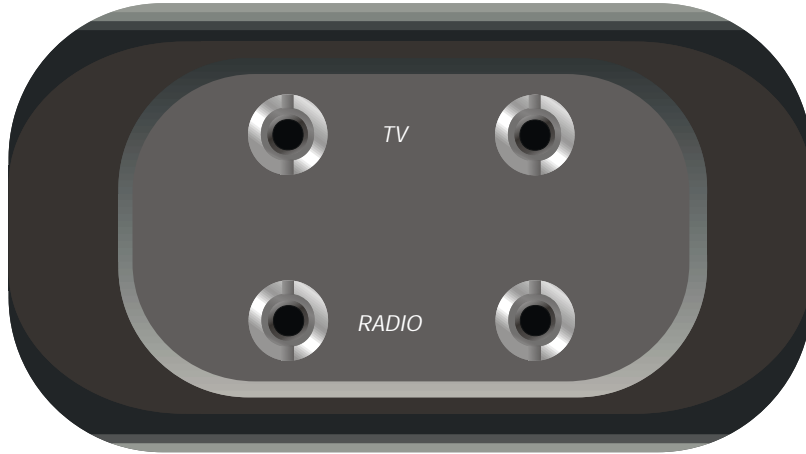

4-JACK TV/RADIO
21030011

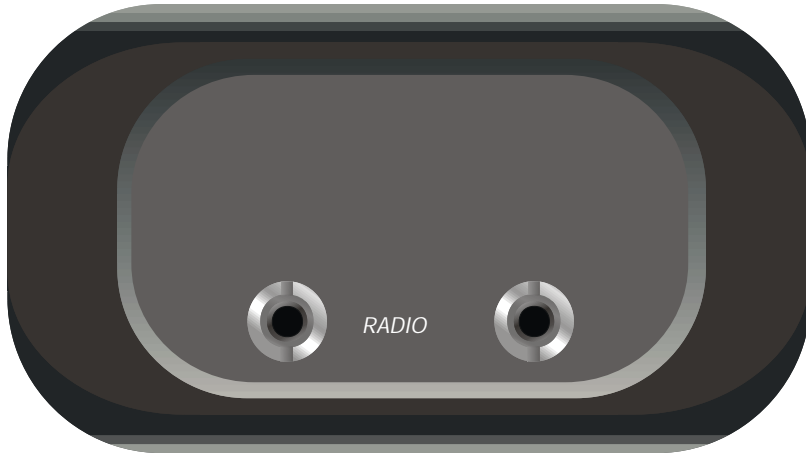

2-JACK RADIO
21030010

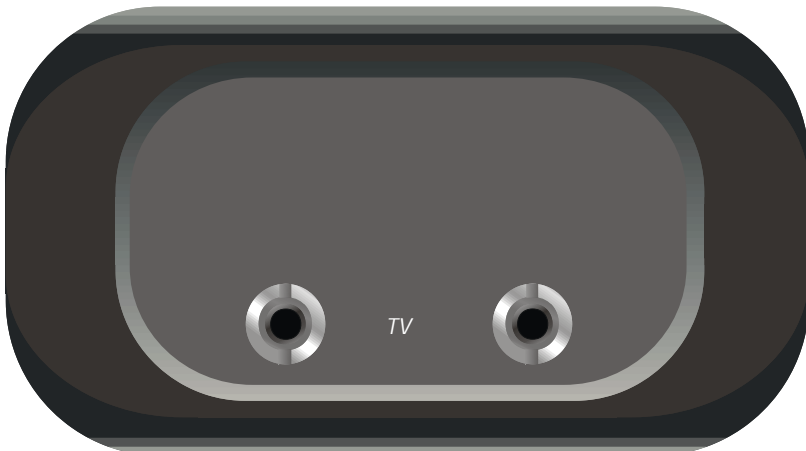

2-JACK TV
21030009

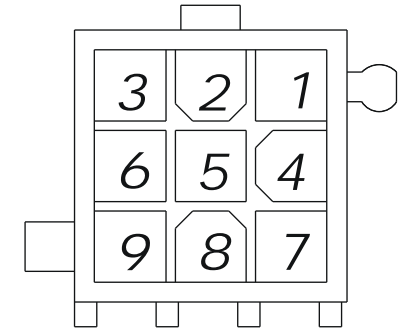

PIN CONNECTIONS

- 1 - RADIO L+
- 2 - TV AUDIO+
- 3 - BACKLIGHT-
- 4 - NOT USED
- 5 - NOT USED
- 6 - BACKLIGHT+
- 7 - RADIO R+
- 8 - RADIO AUDIO-
- 9 - TV AUDIO-

RADIO HEADPHONE STATION Troubleshooting Flowchart

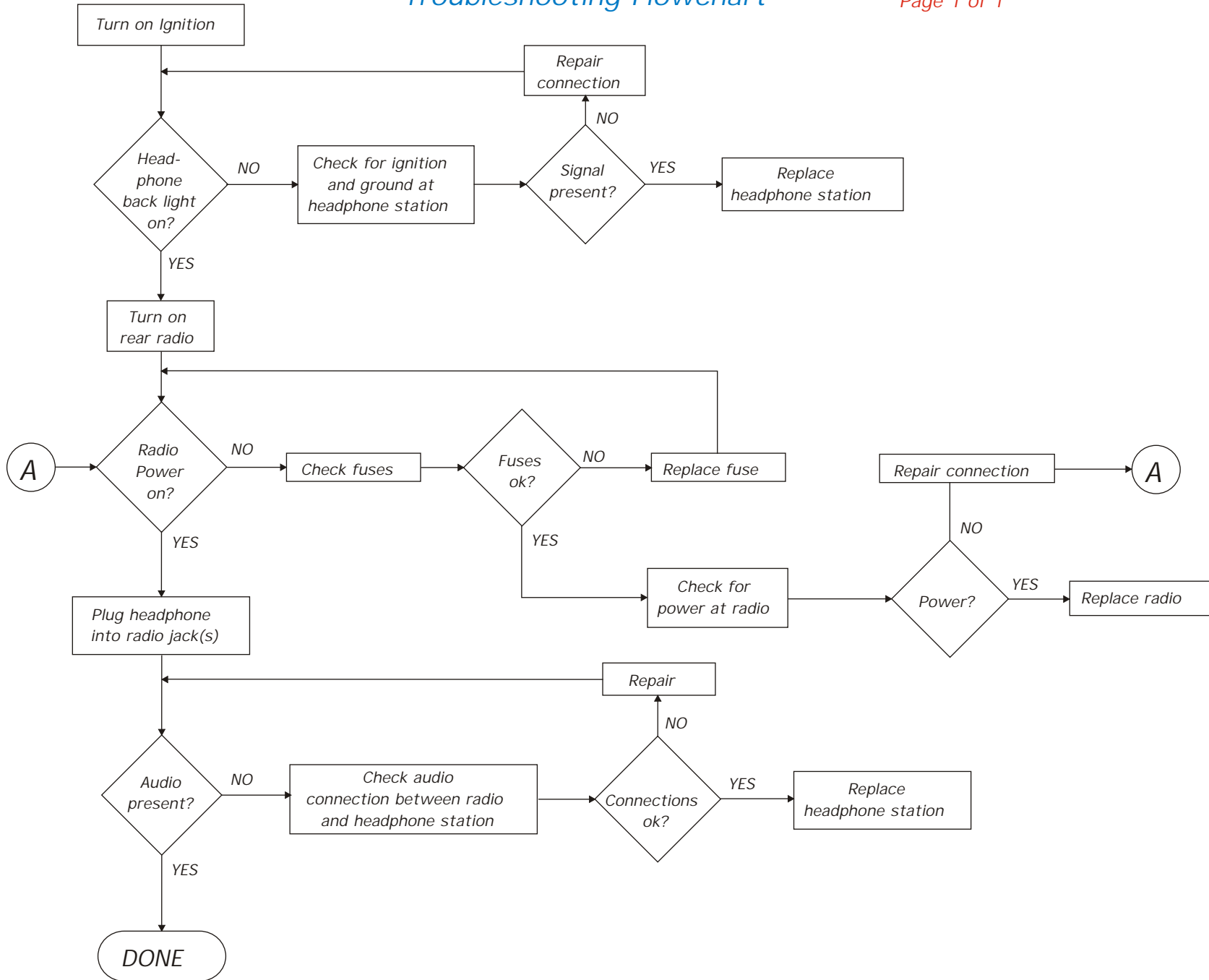

TV HEADPHONE STATION Troubleshooting Flowchart

Page 1 of 1

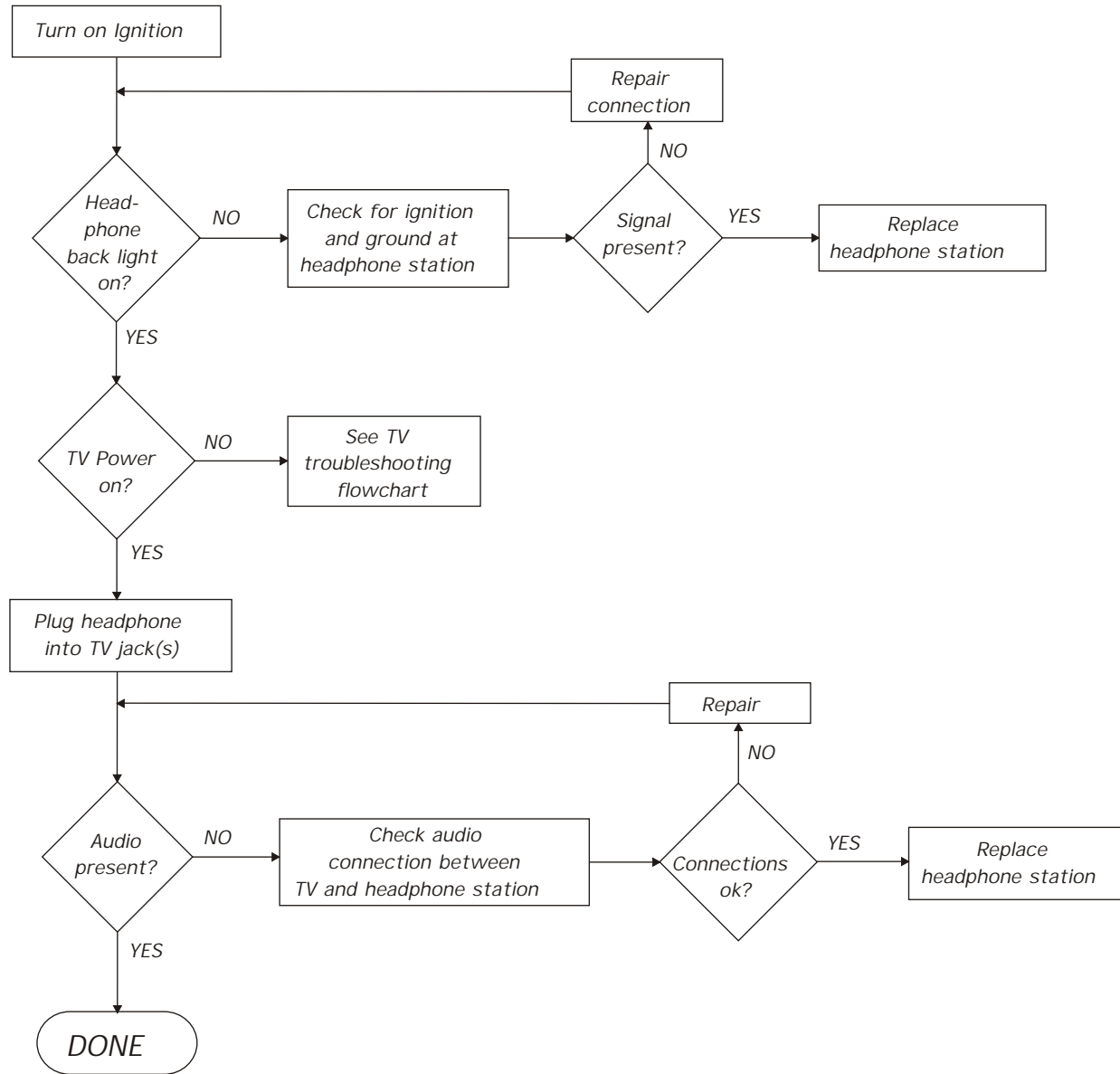

ROCKER SWITCH PANELS

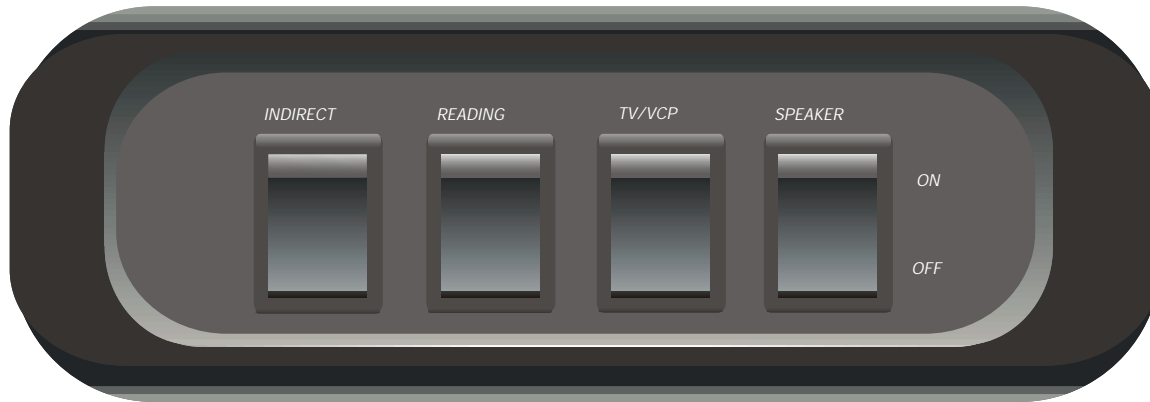

4-Gang Switch Panel

21120022



3-Gang Switch Panel

21120021



2-Gang Switch Panel

21120020

PIN CONNECTIONS

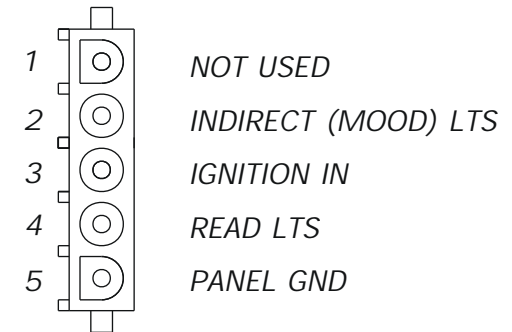
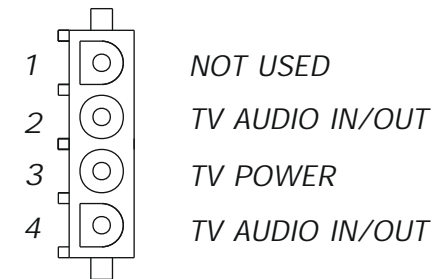

SE TV SPEAKER Troubleshooting Flowchart

Page 1 of 1

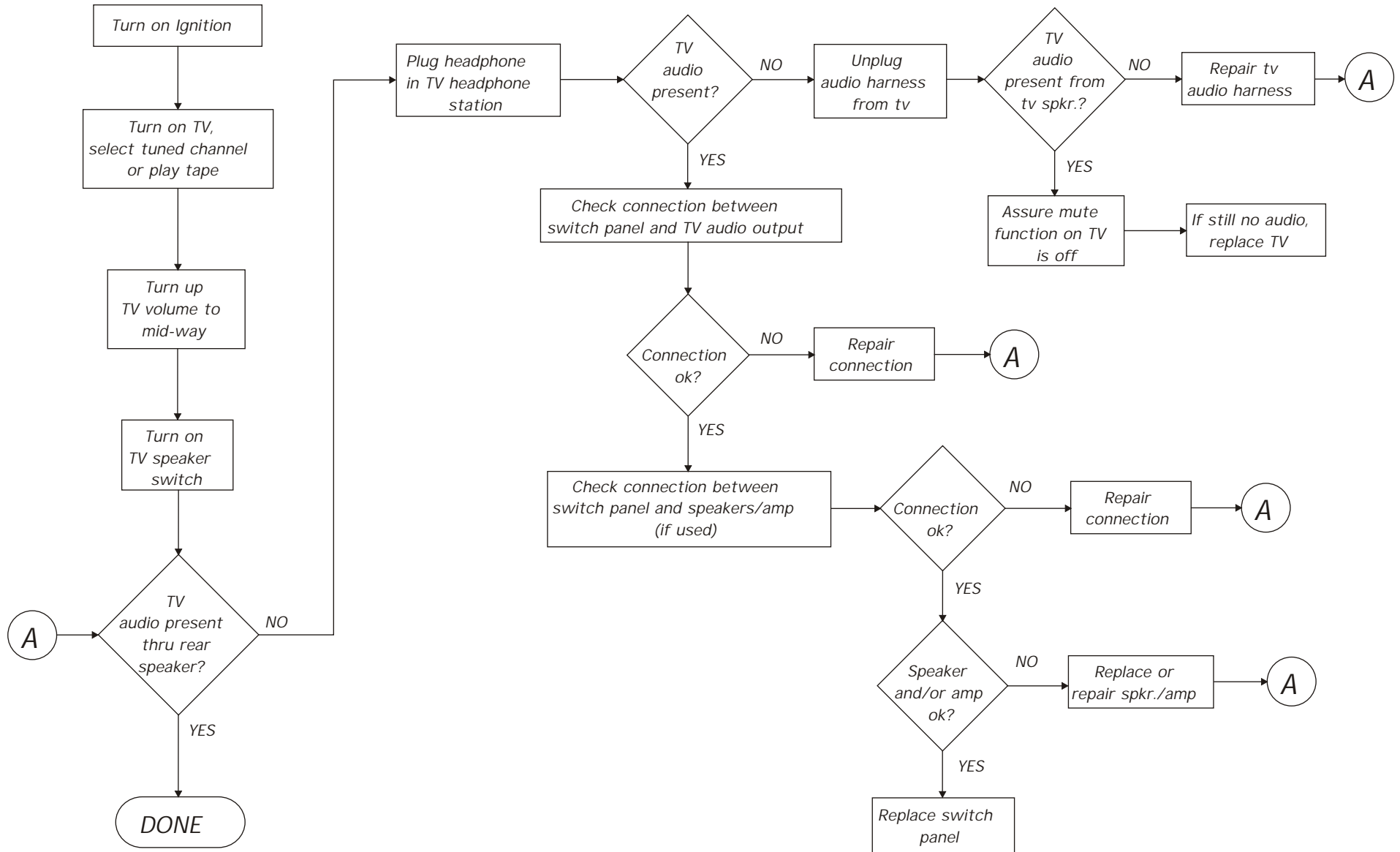

SE TV/VCP POWER Troubleshooting Flowchart

Page 1 of 1

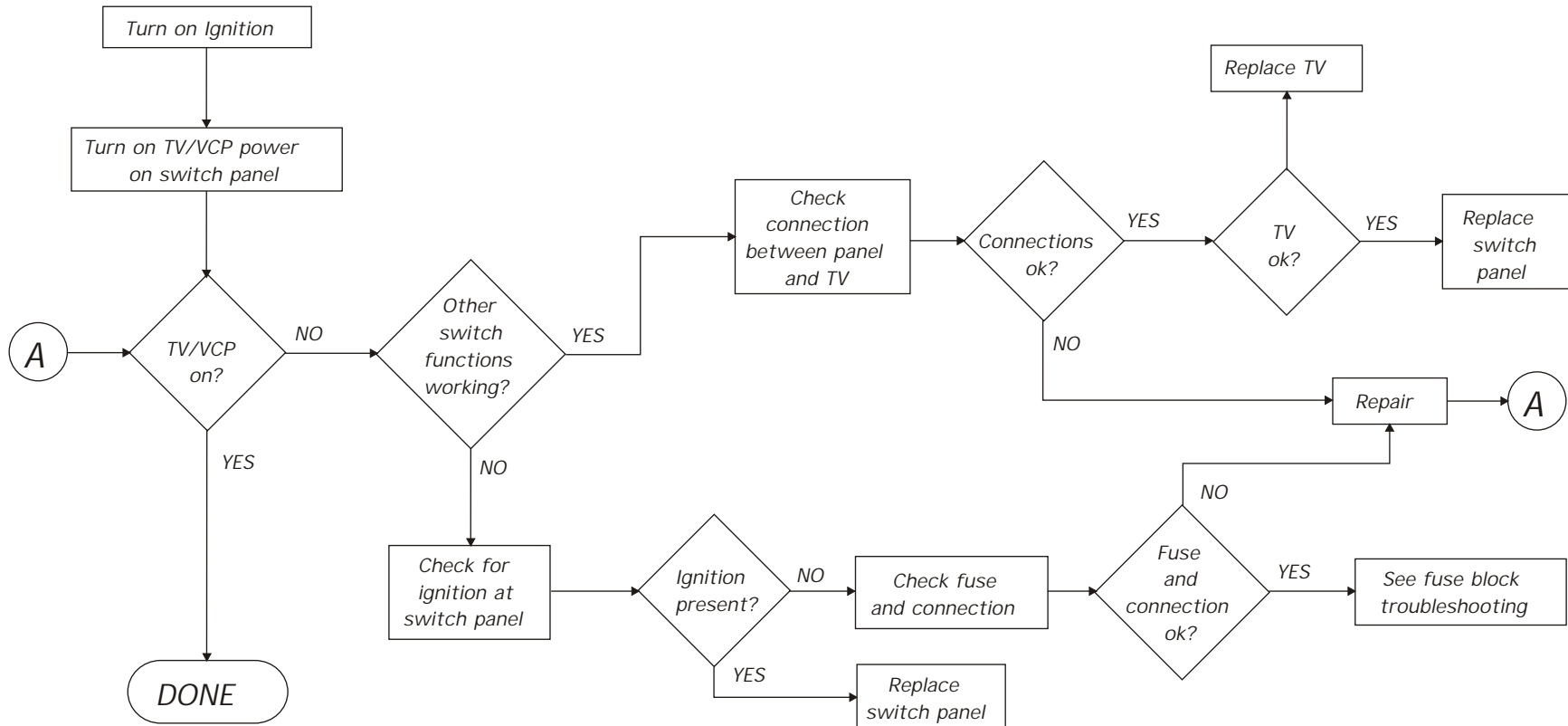

SE INDIRECT/READING LIGHTS Troubleshooting Flowchart

PAGE 1 OF 2

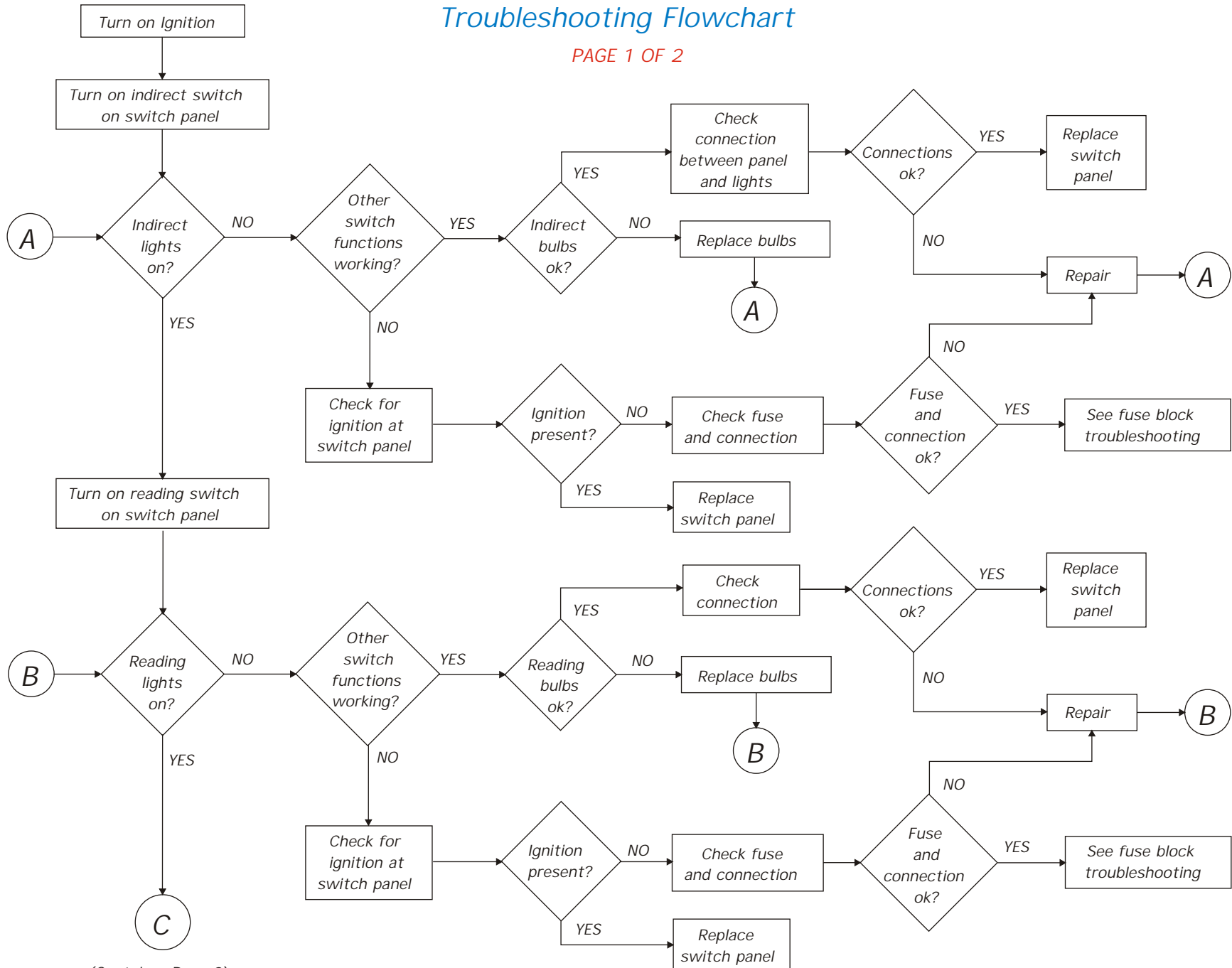

(Cont'd on Page 2)

SE INDIRECT/READING LIGHTS Troubleshooting Flowchart

PAGE 2 OF 2

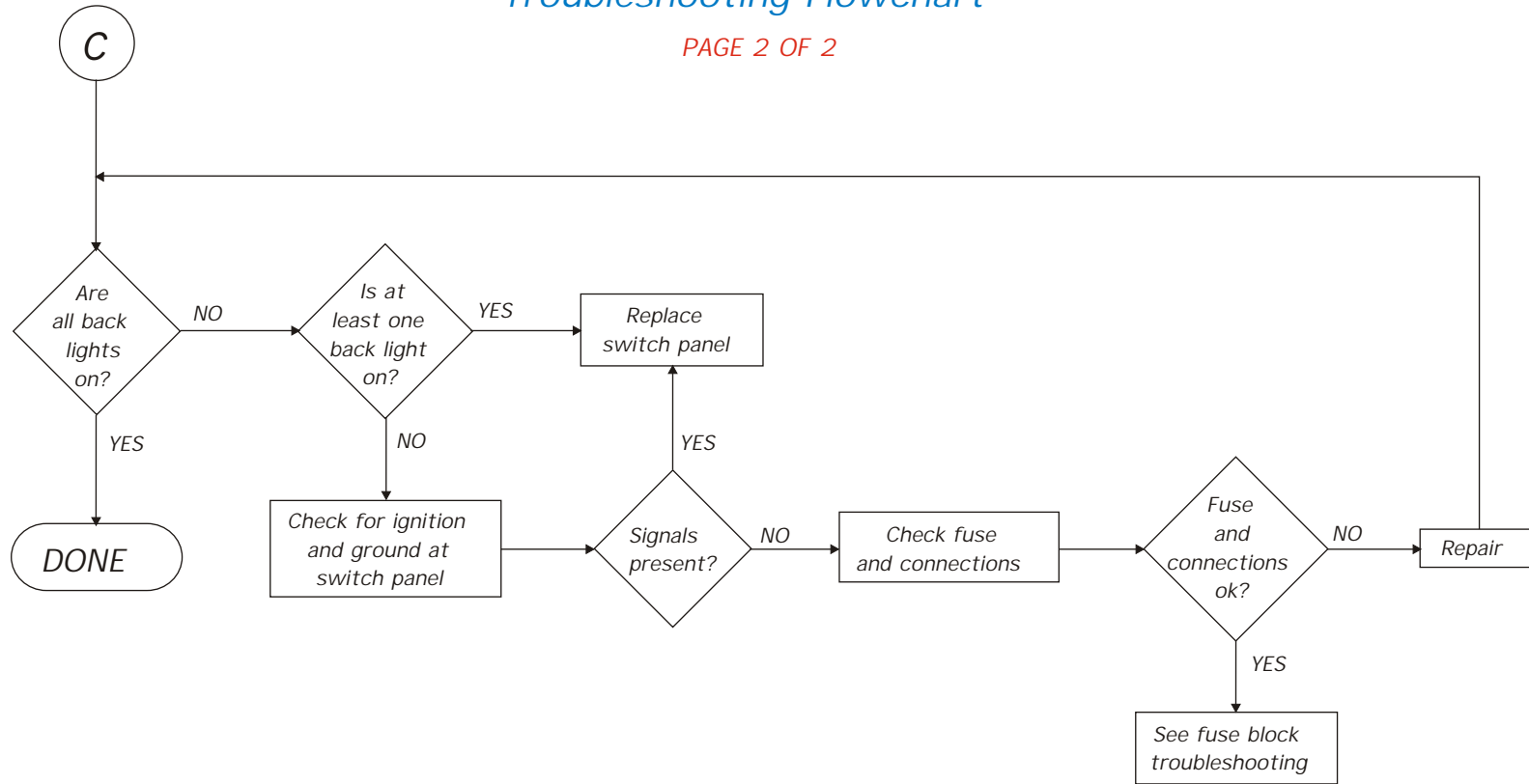

SOFA SWITCH PANEL

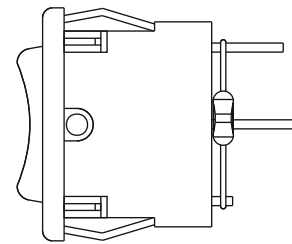

GROUND

SWITCH OUT

21120018

SOFA Troubleshooting Flowchart

Page 1 of 1

